

hope

hope

www.hopetech.com

HOPE TECHNOLOGY (IPCO) LTD
Hope Mill
Barnoldswick, Lancashire
BB18 5PX, United Kingdom

Technical enquiries : tel:00 44 (0) 1282 818 413
e mail: service@hopetech.com
Sales enquiries : tel:00 44 (0) 1282 851 200
e mail: info@hopetech.com

RACE EVO X2 E4

HYDRAULIC DISC BRAKE SYSTEM
MODEL YEAR 2014

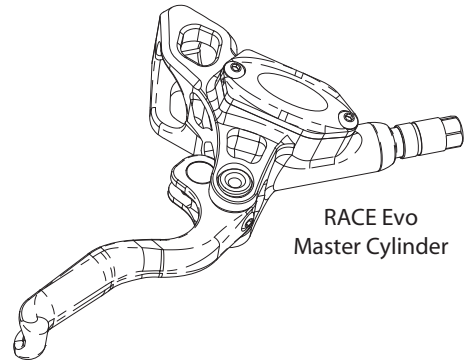

RACE Evo X2 usage chart

DH / FREERIDE	
ENDURO	
ALL MOUNTAIN	
CROSS COUNTRY	
XC RACING	
TRIALS	N/A
ROAD	N/A

RACE Evo E4 usage chart

DH / FREERIDE	
ENDURO	
ALL MOUNTAIN	
CROSS COUNTRY	
XC RACING	
TRIALS	N/A
ROAD	N/A

QUICK INSTALLATION GUIDE

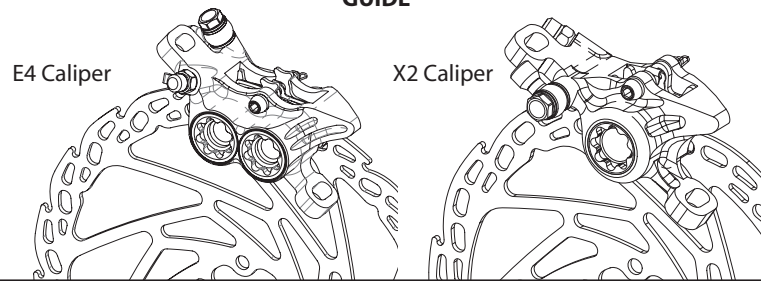

WARNING PLEASE READ FIRST

- . Don't overestimate your technical capacities. This brake system must be fitted by a competent cycle mechanic using the correct tools. Incorrect installation could result in brake failure that could cause serious or fatal injuries.
- . Please refer to the website videos and technical documents for more information including servicing and maintenance - www.hopetech.com / Tech support section.
- The video logo  indicates you can find some useful tips on the website.
- . This brake system has been designed to be used only on two-wheel vehicles with human propulsion. Any other application is not advisable and could result in the failure of this product.
- . Your brake system will generate heat during braking. Never touch either the disc or caliper after long braking period as this could cause severe burns.
- . Before each ride always check the brake for proper function, the brake pad for wear and that there is no system damage resulting in fluid leaks.
- . It's common sense to also check that your wheel's quick release systems are securely installed and tightened.
- . Your braking performance will improve in almost all conditions. Please take time to become familiar with your new brake. Always ride within your own ability.
- . Brake pad contaminated with brake fluid, chain lubricant or unsuitable bike cleaner will need replacing because the overall brake performance will be greatly diminished.
- . If you have any doubts or questions please contact your dealer or the appropriate distributor for your country.
- . If you decide to ignore these important safety warnings and instructions, you are doing so at your own risk and Hope Technology cannot be held responsible for any consequences resulting of the misuse of the brake system.

TOOLS REQUIRED

Once again, don't overestimate your technical skills. If you are not familiar with this sort of installation we advise that this brake system should be fitted by a competent cycle mechanic.

- + Torx T25 driver
- + 5mm Allen key
- + 4mm Allen key
- + 2mm Allen key
- + 8mm spanner
- + Flat blade screw driver

INTRODUCTION

Congratulations, you have just acquired a high end HOPE hydraulic disc brake system proudly made in our Barnoldswick factory in Great Britain. The Race Evo X2 brake has been specially designed for XC racing use meanwhile the Race Evo E4 is more orientated for Enduro but both brakes are aimed for those looking to associate low weight with high braking performances. The new Race Evo master cylinder will give a smooth and progressive feel. It features a split clamp for easy fitting, integrated reservoir for bleeding and adjustable lever reach. The one piece caliper is machined from a solid billet of aircraft spec aluminium. The caliper is designed to offer power and stiffness. As the caliper is PostMount type, depending on forks, frame and rotor size, an adaptor bracket may be required. The full stainless steel or floating rotors are available from Ø140mm (rear only) to Ø203mm, for IS fittings (6 bolts) but also for users of older HOPE Pro3 SP-XC3 and HOPE Pro3 SP-AM4 wheelsets.

BOX CONTENTS

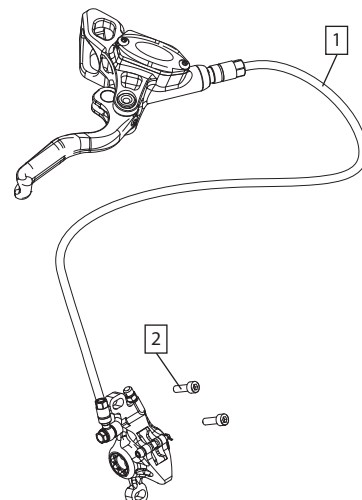

1. Brake system, fully bled (X2 caliper shown)
2. M6 x 18mm caliper bolts

INSTALLATION STEPS

Please refer to the website videos and technical documents if you require more information about setting up this brake system, servicing and maintenance. www.hopetech.com / Tech support section



1. ATTACHING THE DISC TO THE HUB

With this brake system it is highly recommended that you use only HOPE rotors. Our discs have been especially developed to work in association with our calipers and brake pads.

- Attach the disc rotor to the hub using the bolts provided with your disc type (6, 4 or 3 bolts).
 - Make sure that the laser marked arrow on the disc is pointing in the same direction as the forward wheel rotation.
 - Depending on the bolt type, using a Torx 25 driver or 5mm Allen key, tighten the disc bolts in a cross pattern. Recommended tightening torque : 5-6 N.m for M5 bolts, 11-12 N.m for M8 bolts.
- Note : A mild engineering adhesive could be used on disc bolts to prevent them unscrewing. Do not use permanent adhesive.

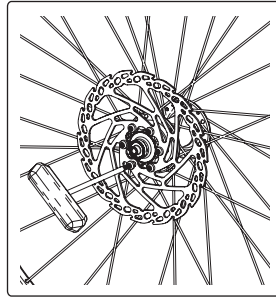

2. ATTACHING THE LEVER TO THE BARS

- Attach the lever assembly to the handlebars. When you are happy with the orientation of the lever, tighten alternately the M5 clamp bolts using a 4mm Allen key. Recommended tightening torque : 4-5 N.m.
- Route the hose and caliper down to the fork brake mount or along the frame to the rear brake mount.

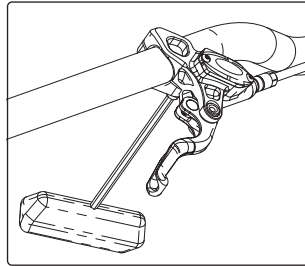

 Avoid situations that could damage the brake hose and/or your bike frame and components

Note: In the first instance it is recommended that you install your brake as supplied without disconnecting and routing the hose through frame guide (if present) or attempting to shorten the hose.

 At a later date you can shorten the brake hose if required. For this operation, follow the instructions in the how to videos of our website.

3. ATTACHING THE CALIPER TO THE FORK OR FRAME

The X2 and E4 calipers are postmount type. You will therefore need to use an adaptor bracket to fit it on IS brake mounts.

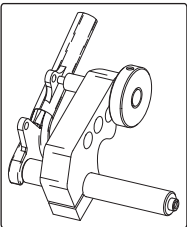

To ensure that the caliper is properly aligned and to help avoid squealing or bad lever feel - prior to fitting the brake, it is important that the tabs of your fork or frame are clear of any paint or burrs.

We recommend that you machine the tabs using a suitable tool such as HOPE Spot Facing tool or similar.

3.1 MOUNTING THE CALIPER ON POSTMOUNT TYPE MOUNTS

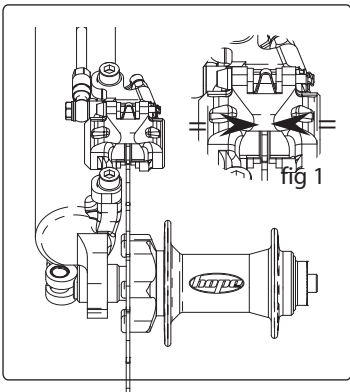

- Before attaching the caliper ensure that the brake pads are fully retracted in the caliper. If not, gently push the piston back using a plastic tyre lever or something similar. Beware not to damage the pads. Take them off if necessary. Push on the left hand side pad backplate to push the right hand side piston and vice versa.

- Mount the wheel fitted with the rotor, ensuring correct fitment in dropouts.

- Position the caliper on the mount and slightly tighten the two M6 bolts.

- At both front and rear of the caliper, adjust its position so it is central over the rotor (see arrows on fig 1) then tighten the two M6 bolts using a 5mm Allen key. Recommended tightening torque 8-9 N.m.



Be careful not to get your fingers caught in the disc when following these steps

Note : We do not recommend pumping the lever to push pads out to align caliper at this point. See section 4 regarding the alignment of pistons.

3.2 MOUNTING THE CALIPER ON IS TYPE MOUNTS



On IS mount you will have to use an adaptor bracket to be able to fit the brake caliper.

- According to the rotor size and type of mounts, attach the suitable adaptor bracket onto the brake tabs and tighten the two M6 bolts using a 5mm Allen key. Recommended tightening torque 8-9 N.m. Illustration fig 2.

- Follow the same instructions as fitting the brake onto a postmount (see previous section). Illustration fig 3.

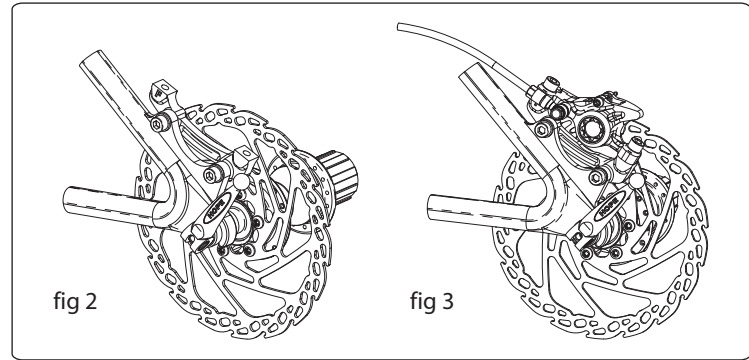

4. CENTRALISE THE PADS OVER THE DISC



This step is very important and mustn't be ignored.

Gently pump the lever in order to bring the pads closer to the disc. One pad might enter in contact with the disc before the other. If this happens, hold the disc against the pad that is already in contact with the disc to allow the other one to move.

For an optimised lever feel, both pads **must** enter in contact with the disc at the same time and allow the same clearance (see arrows) when retracted. The disc should not be flexing at any time.

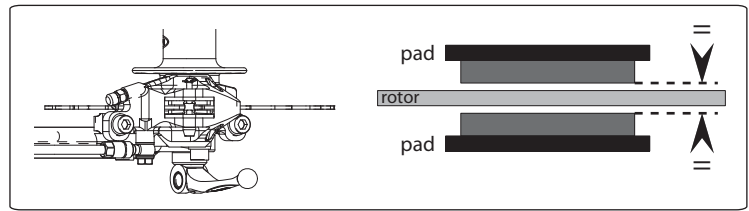

PERSONAL SETTINGS

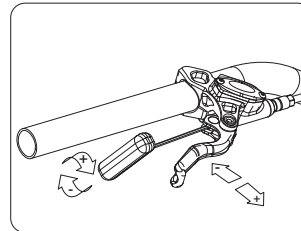

The Race Evo master cylinder only allows the adjustment of the finger reach.

The finger reach adjustment refers to the initial position of the lever blade relative to the bars.

Use a 2mm Allen key, turn the adjuster screw clockwise to increase the reach and anticlockwise to reduce it.

BREAK IN PERIOD AND MAINTENANCE

Before riding and before every ride, check the correct action of the brake and that braking effort is applied as the lever is pulled.

To achieve the maximum braking performance, the new pads will need bedding in. Please note that sintered pads take longer to bed in than organic pads.

To bed in the pads, ride a short distance whilst alternatively gently applying the brake on and off without attempting to stop. This procedure will achieve good braking performance but will reach its full potential after a few rides.

About maintenance tips refers to our "how to" videos on the website. 

To optimise the performance of the brake it is important to keep the caliper pistons lubricated using silicon lubricant only. We advice doing this at least at every pad replacement.

For brake bleeds use only dot 5.1 or dot 4 brake fluid from a clean container.

WARRANTY

All Hope Technology disc brake systems are covered for 2 years from original date of purchase against manufacturer defects in material and workmanship. Proof of purchase is required. Products must be returned to the original place of purchase or to Hope Technology to process any warranty claim.

This warranty does not cover any damage caused through mis-use or failing to comply by the recommendations given in this manual.

This warranty does not affect your statutory rights.